

RC2 “Pacific”

PRODUCT MANUAL



IMPORTANT SAFETY INSTRUCTIONS

PERTAINING TO A RISK OF FIRE, ELECTRIC SHOCK, FETAL INJURY, DROWNING, HYPERTHERMIA, OR INJURY TO PERSONS

READ AND FOLLOW ALL INSTRUCTIONS



WARNING: RISK OF FETAL INJURY; Pregnant or possibly pregnant women should consult a Physician before using a hydromassage bathtub equipped with a heater.



WARNING: RISK OF ELECTRIC SHOCK.

- The unit must be connected to a supply circuit that is protected by a Ground-Fault Circuit-Interrupter (GFCI) installed by a qualified service representative or Licensed Electrician.
- Install this unit in accordance with the Canadian Electric Code, part I. the control provided with this unit shall be installed out of reach of persons occupying the tub in accordance with the Canadian Electrical Code , part I "*for unit with a control not integral with the tub.*"
- Do not permit electrical appliances (such as a hair dryer, lamp, telephone, radio, or television) within 5 feet or 1.5 meters of this hydromassage bathtub.
- GFCI should be tested on a routine basis. To test the GFCI, push the test button. The GFCI should interrupt power. Push the reset button. Power should be restored. If the GFCI fails to operate in this manner, the GFCI is defective. If the GFCI interrupts power without the test button being pushed there is ground current flowing, indicating the possibility of an electric shock. Do not use this hydromassage bathtub. Disconnect the hydromassage bathtub and have the problem corrected by a qualified service representative or Licensed Electrician before using.



WARNING: RISK OF ACCIDENTAL INJURY AND DROWNING;

- Children should not use hydromassage bathtub without adult supervision.
- Do not use hydromassage bathtub unless all suction guards are installed to prevent body hair entrapment.
- Do not use drugs or alcohol before or during the use of the hydromassage bathtub equipped with heater to avoid unconsciousness and possible drowning.
- People using medications and/or having an adverse medical history should consult a Physician before using a hydromassage bathtub equipped with a heater.



WARNING: RISK OF HYPERTHERMIA

- Do not use a hydromassage bathtub equipped with a heater immediately following strenuous exercise.
- Water temperature in excess of 100° Fahrenheit or 38° Celsius may be hazardous to your health. Check and adjust water temperature before use.
- Prolonged immersion in water hotter than normal body temperature may introduce hyperthermia.
- Symptoms of Hyperthermia;
 - Heat stroke can be life-threatening and victims can die. A person with heat stroke usually has a body temperature above 104° Fahrenheit. Other symptoms include confusion, combativeness, bizarre behavior, faintness, staggering, strong and rapid pulse, and possible delirium or coma. High body temperature is capable of producing irreversible brain damage.
 - Heat fatigue is a feeling of weakness brought on by high outdoor temperature. Symptoms include cool, moist skin and a weakened pulse. The person may feel faint.
 - Heat syncope is a sudden dizziness experienced after exercising in the heat. The skin appears pale and sweaty but is generally moist and cool. The pulse is weakened and the heart rate is usually rapid. Body temperature is normal.
 - Heat cramps are painful muscle spasms in the abdomen, arms, or legs following strenuous activity. Heat cramps are caused by a lack of salt in the body.
 - Heat exhaustion is a warning that the body is getting too hot. The person may be thirsty, giddy, weak, uncoordinated, nauseated and sweating profusely. The body temperature is normal and the pulse is normal or raised. The skin is cold and clammy.



WARNING: Do not permit children to use this unit unless they are closely supervised at all times.



WARNING: Exercise care when entering or exiting the hydromassage bathtub.



WARNING: Use this unit only for its intended use as described in this manual. Do not use attachments unless recommended by the manufacturer.



WARNING: Do not drop or insert any objects into any openings.



WARNING: Do not operate this unit without the guard over the suction fitting.



WARNING: Service or repair work needed for this hydromassage bathtub other than normal cleaning or care should be performed by an authorized and qualified service representative.

SAVE THESE INSTRUCTIONS

This manual is intended to ensure that the equipment performs to your satisfaction. The following information is crucial to the proper operation of the equipment, and will allow for a great bathing experience for both the caregiver and the one being cared for.

If there are any questions during the installation or operation of this unit, please contact the Authorized Dealer or Distributor from whom the Product was purchased.



This symbol is used throughout this manual to highlight item of importance or safety. Please pay special attention to these items with this symbol to ensure proper and safe operation of the unit.

Table of Contents

Technical Specifications..... Section 1

Using the Tub..... Section 2

Pre-Installation and Dimensions..... Section 3

Installing the Tub..... Section 4

Warranty and Disclaimer..... Section 5

Maintenance and Adjustments..... Section 6

Troubleshooting..... Section 7

Parts Section 8

Technical Specifications

Description: Model RC2 is a freestanding or built-in, 75-gallon side access bathing tub.

Construction: The tub shell consists of a 3/16" thick fiberglass-reinforced polyester laminate. Critical areas are reinforced with a 1/4" thick core of end-grain balsa and additional layers of fortifying laminate. The sanitary gelcoat is an ISO/NPG type-finish. The tub frame is welded aircraft grade aluminum box tube.

Side Access Door: The water tight inward swing door has a compression-type seal.

Front Access Panel: The front access panel can be removed allowing access to the drain, legs, whirlpool motor, plumbing, and air spa motor.

Drain and Overflow Assembly: An ample 1 1/2" drain is installed with an overflow.

Hand-Held Shower: A chrome, hand-held shower wand with a flexible hose retracts out of site and is mounted to the deck of the tub.

Contour Grab Bars: 7 1/2" white contoured grab bar securely mounted on the interior of the tub.

Leveling Legs: The sturdy stainless steel leveling legs will adjust up to 2" per leg.

Air Spa (if equipped): The Air Spa System is a hygienic and low maintenance hydromassage system featuring 12 air jets with spring loaded check valves for back flow prevention, which prevents water from entering the air lines. Unlike most other whirlpool and air spa systems, the Air Spa System does not allow water to enter the air lines, which may become a breeding-ground for bacteria and mold. The Air Spa System is a highly efficient hydromassage system that simplifies disinfection and reduces the possibility of cross-contamination. The motor is quiet, efficient, and has a ceramic heating element that blows warm air to help maintain the water temperature and warm the surface of the tub.

Whirlpool (Supreme models): The whirlpool system has 8 jets and a 1-horsepower pump with a pneumatic actuator switch and air control dial. The pump is quiet, efficient, and has a ceramic heating element that warms the water to help maintain the temperature.

Chromatherapy (Supreme models): Is a surface mounted high brightness LED light that produces 7 different colors designed to stimulate physical, psychological, and emotional responses.

Aromatherapy (Supreme models): Diffuses the natural aroma of essential oils into the ambient air, which induces a state of relaxation, well-being, and relief.

PERFORMANCE DATA:

Water Capacity (unoccupied): 75 Gallons / 284 L

Fill-Time (approx.): 6 minutes, 15 seconds

Drain Time (approx.): 2 minutes, 45 seconds

Weight Capacity (occupant): 350 lbs. / 159 kg

MANUFACTURING AND TESTING:

This unit is manufactured in Sparta, Tennessee, USA. Each unit passes a thorough quality control review and is tested for proper operation prior to shipping.

SERVICE CONNECTIONS:

Drain: 1 1/2" PVC outlet

Electrical: 115V AC, 60Hz, 15A (GFCI outlet required)

Water Supply Inlet: 3/4"

WARRANTY:

Please reference section 5 for complete warranty details.

Certifications / Standards: A112.19.7-2012 / CSA B45.10-12 / UL 1795 / CSA C22.2 no. 218.2

IAPMO Z124-2011 / CSA B45.5-11

Using the Tub

Operating Instructions:

- To open the door, pull upward on door handle
- Step inside tub and lower yourself to the contoured seat.
- Push door shut, grasp handle and push forward until the handle stops and the door is in the locked position.
- Turn the diverter lever towards the tub spout and turn on the water. Check the temperature with your hand as you fill tub, adjust the temperature accordingly.
- Insert the drain plug or close the drain using the cable drain knob (if equipped)
- Fill the tub to the desired level.
- To use the shower wand, turn the diverter lever towards the shower wand until the water comes out of the shower wand.
- When finished bathing, pull the drain plug or open the drain using the cable drain knob (if equipped)
- When the tub is empty, open the door and exit the tub.



TEMPERATURES OVER 110 DEGREES FAHRENHEIT CAN SCALD!

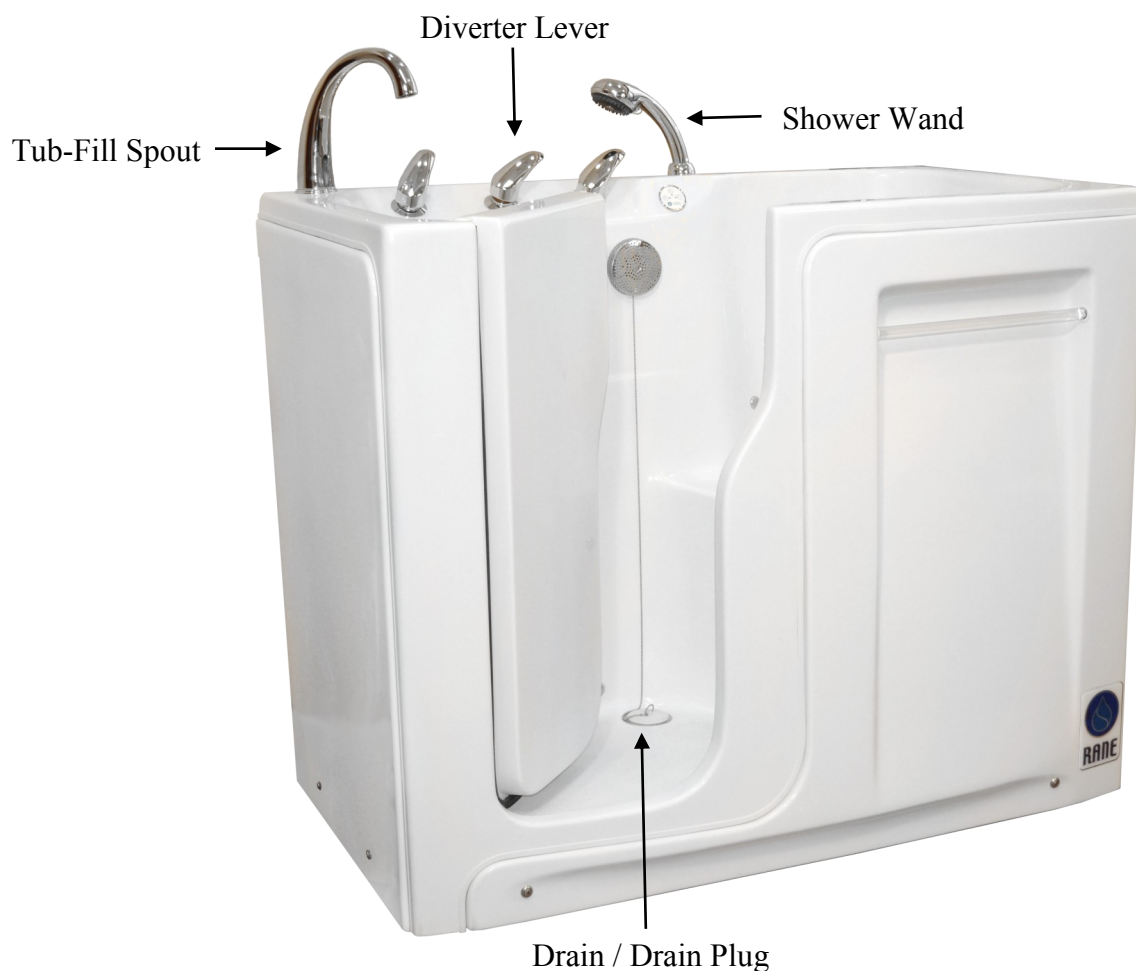

Using the Tub

AIR SPA (if equipped)

ON/OFF BUTTON

- 1st press: Blower turns on at high speed
- 2nd press: Blower changes to lo speed
- 3rd press: Blower turns off



An automatic drying cycle will start 10 minutes after the blower is turned off and run for 1 minute. If using the Touch / Keypad, the ON/OFF button will blink (red LED) indicating the drying cycle is triggered.

WHIRLPOOL (if equipped)

ON/OFF BUTTON

- 1st press: Pump starts
- 2nd press: Pump stops

AIR CONTROL

- Turn clockwise: Amount of air mixed with water will decrease (-)
- Turn counterclockwise: Amount of air mixed with water will increase (+)

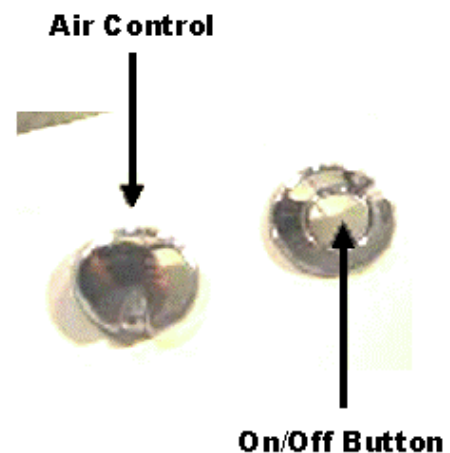

Using the Tub

AROMATHERAPY (if equipped)

1. Remove chrome cap and add 2 or 3 drops of your choice of essential oil to 1 ounce of water into the diffuser.
2. Turn on by pressing the On / Off button on the touch / keypad.
3. One turned on, the diffuser projects the natural flavor or the essential oil into the ambient air for approximately 20 minutes.

* *Do not pour essential oils directly into the diffuser, always mix with water. 2 to 3 drops of essential oil to 1 ounce of water.*

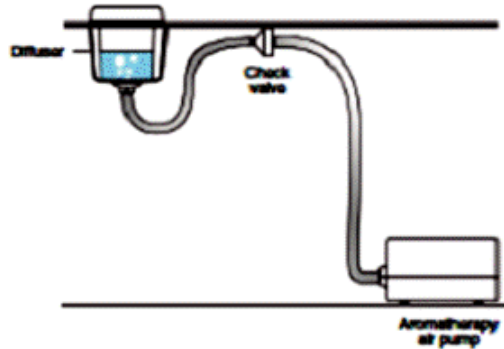

CHROMATHERAPY (if equipped)

ON/OFF BUTTON

- Press 2x times quickly within three seconds:
Light turns on and will change to the Rainbow Cycle (low speed)
- Press 3x times quickly within three seconds:
Light turns on and will change to the Rainbow Cycle (high speed)
- Press and hold for two seconds:
Lights turn off
- *Rainbow Cycle: Light cycles through all 7 colors continually.*



To have one color continually or scroll through and choose a specific color:

Press the On/Off Button 1x (*pause at least three seconds between each press*)

- 1st press: White
- 2nd press: Turquoise
- 3rd press: Blue
- 4th press: Magenta
- 5th press: Red
- 6th press: Orange
- 7th press: Yellow
- 8th press: Green

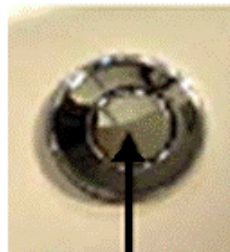

On/Off Button

Pre-Installation Drawings and Dimensions

RC2 Front View Dimensions

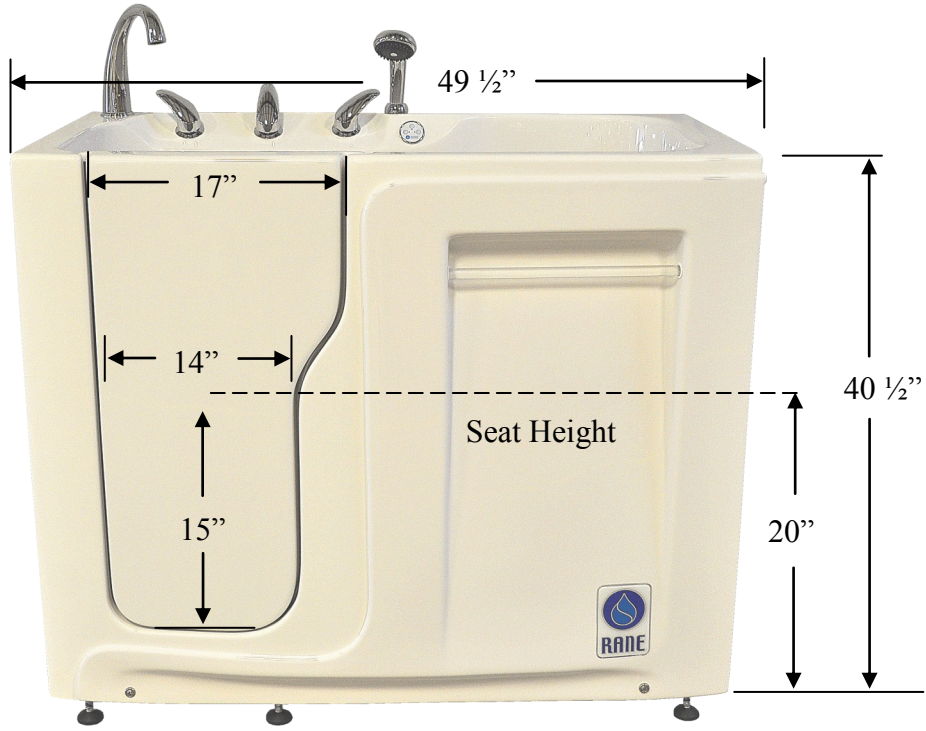

RC2 Top View Dimensions

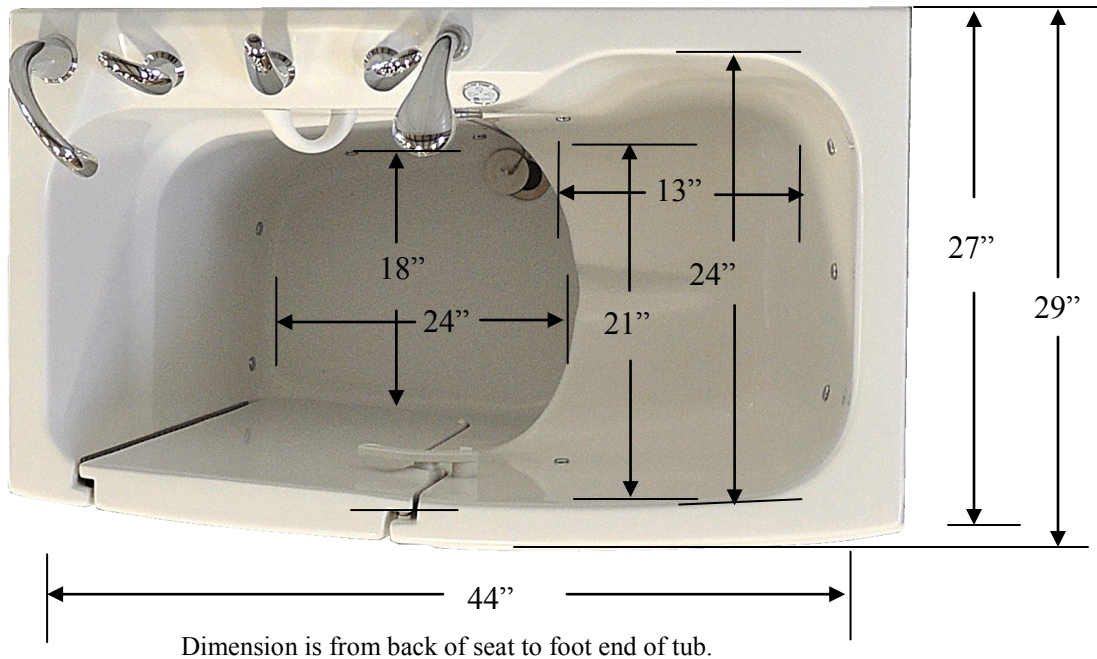

Pre-Installation Drawings and Dimensions

RC2 Plumbing View Dimensions

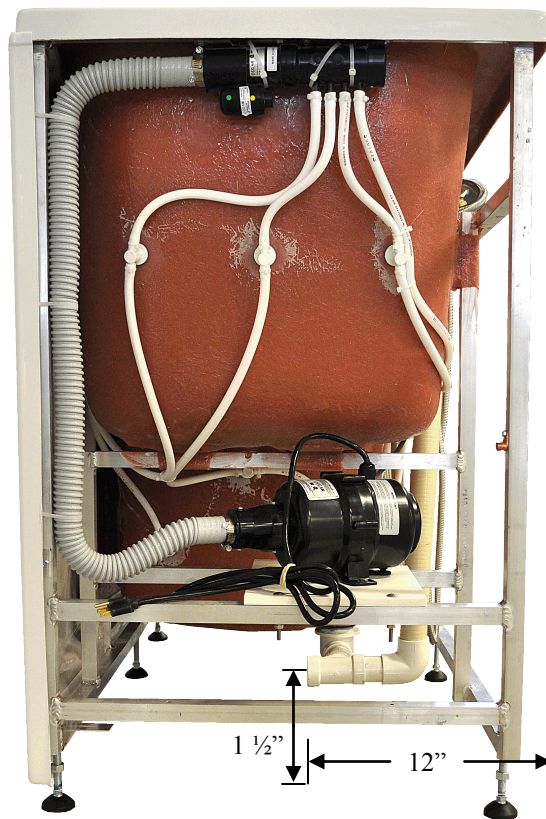

RC2 Plumbing View Dimensions



Installing the Tub

The RC2 is designed to be installed as freestanding units or built into an alcove. Several items of precaution should be taken during installation:

- **USE THIS PRODUCT ONLY FOR ITS INTENDED USE AS DESCRIBED FURTHER IN THESE INSTRUCTIONS**
- **DURING CONSTRUCTION, THE TUB'S SHELL IS VULNERABLE TO DAMAGE CAUSED BY FALLING OBJECTS. DO NOT STAND IN THE TUB DURING INSTALLATION.**
- **NEVER STORE ANY CONSTRUCTION MATERIALS INSIDE THE TUB.**
- **PRINTED DIMENSIONS ARE FOR REFERENCE ONLY. ACTUAL MEASUREMENTS SHOULD BE TAKEN FROM THE TUB DURING INSTALL.**
- **THE TUB MUST BE WATER TESTED FOR LEAKS BEFORE THE TUB IS COMPLETELY ENCLOSED AND INSTALLED.**

Step 1: Determine final location and review framework for the tub. Install rough-in plumbing and electrical hook-ups according to relevant building codes and regulations. If installing into an alcove, the tub should slide into the final location without binding. Please review section 3 for rough-in dimensions and allow for the spacing needed, along with the space requirements for lifting devices.

Step 2: Remove all packing material and cardboard packaging from tub. Set aside the accessory box which is located underneath or in the tub. Remove the tub from the pallet. Make sure that the door is in the closed position during installation, which will help maintain the true shape of the tub itself.



NOTE: Check all applicable building codes. All electrical and plumbing work must be performed by qualified personnel.

Step 3: Level the tub in its final location. Check to see that the unit is level by using a 4' level across the back, front and sides of the tub.

Step 4: Before hooking up the two 3/4" water lines, clean the main hot and cold water supply lines of debris prior to connection. Valves, shower wand, and accessories may become clogged and or damaged if the lines are not free of debris. **The warranty does not cover damage caused debris in the lines.**

Step 5: Connect the hot and cold water inlet hoses to the main supply lines. Make sure that the hose screens are present (see below) and that the hoses are not bent or kinked. The hoses sent with the tub are "National Pipe Thread".

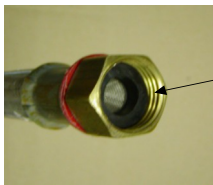

Make sure hose screen is present and inserted properly.

Step 6: Connect the drain. If the tub has an air spa blower or whirlpool pump, plug the cords into the GFCI outlet.

Step 7: Attach any accessories including the shower wand and tub spout. The shower wand hose is concealed inside the tub and can be pulled out.

Step 8: Be sure to clean the tub prior to filling the tub. Debris may damage the finish of the tub and will not be covered under warranty. Water test the unit for proper operation and check for any leaks. If no leaks, remove any install labels and directions. Clean tub and prepare for daily use with warm water and a non-abrasive cleaner.



NOTE: The thorough inspection and startup of the tub is required before first use. It is the installer's responsibility to check and tighten the threaded connections on all parts of the tub.



LIMITED WARRANTY

Rane® Safety and Accessibility products are warranted to be free from defects in materials and workmanship for a period of **five (5) years** for external finishes and composite shell, **three (3) years** for all moving and stationary parts, including but not limited to, valves, air spa blower, whirlpool pumps, actuators, door mechanisms, hinges, gauges, thermometers, and **Lifetime** for the door seal (provided preventative maintenance is performed as recommended.) *Shower and disinfectant hoses, handheld shower wands, disinfectant spray wands, and batteries are excluded from this warranty.*

ALWAYS FOLLOW ALL SAFETY AND USE INSTRUCTIONS CONTAINED IN THE TUB AND LIFT USE MANUALS.

COMMENCEMENT OF WARRANTY PERIOD

Warranty commences on the date of shipment to Customer and/or Dealer.

REPAIR OR REPLACEMENT

During the warranty period, Rane® will repair or replace any defective parts or portion thereof returned by Customer and/or Dealer if Rane® determines was **defective due to faulty materials or workmanship**. The Customer and/or Dealer must obtain and **Return Goods Authorization (RGA)** number from Rane®. *The Customer and/or Dealer will pay all related labor and return costs incurred in the replacement, installation, or repair of the defective parts or portion thereof to Rane® except that in year one Rane® will pay for shipping.* Rane® retains the exclusive right to repair or replace the defective products or parts or portions thereof at its sole discretion. In the event that it is determined that the cost of warranty repairs and/or parts is excessive, Rane® may require the Customer and/or Dealer to provide a written report and pictures of the defect for review. In the event that replacement parts are sent by Rane® to the Customer and/or Dealer before the defective parts have been received and reviewed by Rane®, the Customer and/or Dealer will be invoiced for the replacement parts and shipping costs. Once the defective parts have been received by Rane®, and deemed to be defective due to faulty materials or workmanship, a credit or refund will be issued to the Customer and/or Dealer. In the event Rane® determines the repairs and/or parts were not covered by warranty due to misuse or other reasons, customer shall pay for the charges for all repairs including parts, freight, and labor warranty of parts subject to “normal wear and tear” (i.e. cushions, pads, lap and shoulder belts, shower wands, and hoses) are not covered under this warranty except as it applies to the defects in materials and workmanship.

EXCLUSIONS

This limited warranty applies only to the Rane® tubs sold and used in Canada or the United States, and does not apply to equipment that has been damaged or rendered defective as a result of:

- a) Acts of God, accident, misuse, neglect, or abuse
- b) Use of parts not manufactured or sold by Rane®
- c) Modification without the written permission of Rane®
- d) Service by anyone other than Rane® or a Rane® Authorized Agent
- e) Transit, neglect, misuse, power surge, or operating environment
- f) **Failure to inspect tub upon delivery for shipping damage will void any liability of Rane® since shipping damage that is not indicated on the accepted shipping documents as this excuses shipper from any liability**

12/2016 MGM



LIMITED WARRANTY

- g) Failure to provide regular maintenance, service, or inspections
- h) Failure to operate in accordance with manufacturer's guidelines or any other improper operation or maintenance, or
- i) Any other cause not directly and primarily caused by defective material, workmanship, or design including abnormal water conditions including without limitation excessive hardness or acidity or temperatures above prescribed amounts.

Service performed as a result of these conditions will be subject to charges for labor, transportation and shipping, and parts.

Rane® will not be responsible for any water damage to structures or property for any reason including but not limited to manufacturer defects or improper installation. Rane® will assume no responsibility for the loss of the system, inconvenience due to loss, damage to real or personal property or any other consequential damage. Rane® will not be liable for any labor or incidental expenses or material charges in connection with removal or replacement of the walk-in bathtub or any part or parts of the System.

SOLE WARRANTY

These express warranties shall be the sole and exclusive warranties of Rane®, with respect to the tubs ("goods") and services provided in connection with the goods and shall be in lieu of, and exclude, all other express or implied warranties of any kind whatsoever, including to the maximum extent permitted by law warranties of merchantability and fitness for a particular purpose. In no event shall Rane®, its subsidiaries, affiliates, agents, or employees be liable for any incidental indirect, special, or consequential damages in connection with or arising out of the warranties contained herein or the sale or furnishing of any goods, services, or other items hereunder, or any third party's ownership, maintenance or use of any goods, services or other items furnished hereunder including, but not limited to, lost profits or revenues, loss of use of the goods or any associated products, damage to associated products, costs of capital, costs of substitute goods or products, or claims of customers for such damages. In no event shall Rane®, its subsidiaries, affiliates, agents or employees be liable for the negligence or other intentional misconduct of any third-party nor shall Rane® be liable for its gross negligence, or intentional misconduct. The sole remedy for any liability of Rane® of any kind, including, but not limited to, gross negligence, fraud, or intentional misconduct, with respect to any goods, services or other item or service to which these warranties are applicable or otherwise, shall be limited to the repair or replacement of any goods determined by Rane® to be defective hereunder, and in no event shall Rane® be liable for damages in any amount exceeding Rane's® replacement cost of the claimed defective product. Rane® will not be responsible for meeting any federal, state, local, or municipal code or specification (whether statutory, regulatory, or contractual), including special building or construction codes, unless Buyer so specifies in writing at the time of order and an authorized employee of Rane® agrees in writing.

The parties knowingly and willingly waive any right they have under applicable law to a trial by jury in any dispute arising out of or in any way related to these warranties of the issues raised by that dispute.

The Laws of the State of Tennessee shall govern the validity and construction of these warranties and all rights and obligations of, and disputes between or among, the parties arising out of or related to these warranties, whether in contract, tort or otherwise, without regard to the principles of conflict of Laws of the State of Tennessee. The parties submit to the jurisdiction of all State and Federal Courts sitting in the State of Tennessee, and all actions and proceedings arising out of or relating to these warranties shall be heard and determined in a State or Federal Court in Tennessee.

12/2016 MGM

Maintenance and Adjustments

HOW TO ADJUST A LEAKING DOOR? (RA2, RC2, & RE2 MODELS) TOOLS NEEDED: PENCIL, PHILLIPS SCREWDRIVER, SILICONE (if needed)

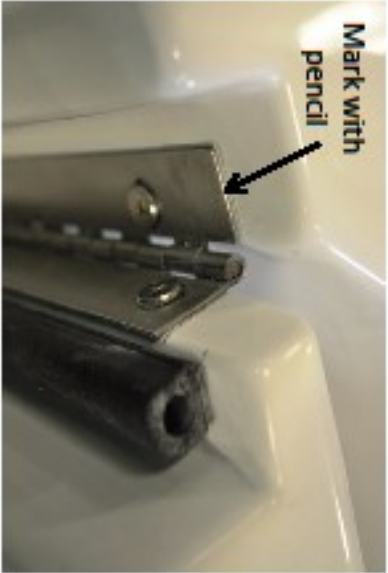

Step 1: Mark with a pencil where hinge is seated

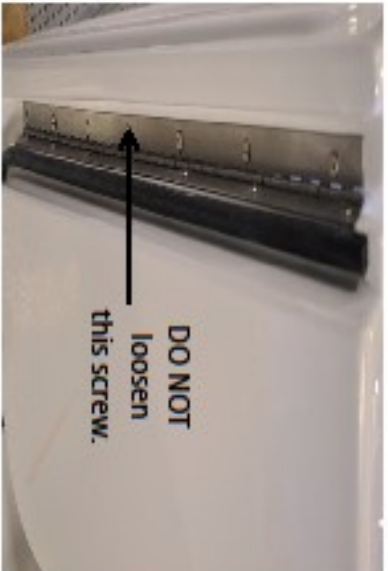

Step 2: Loosen the screws that attach the hinge to the tub, * except the center screw.



Step 3: Move top of hinge "in" a 1/8". This action will cause the bottom of hinge to move "out" a 1/8". This action will pull the bottom of the door towards the outside of the tub, thus making the seal tighter.

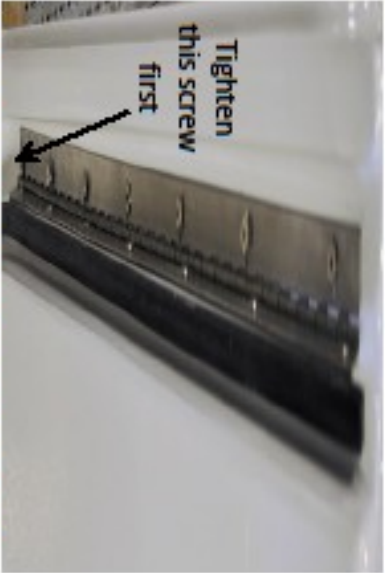

Step 4: Tighten screws from the bottom working up to top screw. Use a hand screwdriver and **do not over tighten screws**, as this will strip screw holes. Silicone screw holes (if needed).



Step 5: Close and latch door. Fill tub with water to see if leak is fixed. If door is still leaking repeat steps 2-4.

Maintenance and Adjustments

Replacing Door Seal

Contents of Door Seal Kit

- Door Seal
- Instructions

Instructions

1. Remove the existing door seal by peeling off the seal.
2. There will be excess glue and seal that will be left behind. Remove these pieces from the door surface using a solvent.
3. Make sure that the door is completely clean and free from any debris.
4. On the new door seal, peel the red tape off of the seal back about 4" at a time.
5. Beginning at one end of the door, place the seal on the edge of the door so the seal and side of the door are flush.



NOTE: THE USE OF PETROLEUM BASED CLEANERS OR LUBRICANTS WILL CAUSE THE RUBBER DOOR SEAL TO FAIL. TO CLEAN THE SEAL, USE MILD WARM SOAPY WATER OR PRODUCTS THAT ARE DESIGNED SPECIFICALLY FOR RUBBER PRODUCTS.



Maintenance and Adjustments

Routine Maintenance

Please contact the Authorized Dealer or Distributor from whom the Product was purchased for periodic updates to this schedule.

Model # _____

Serial # _____

Check List	Monthly	3 Months	6 Months	Yearly
Check door seal for wear			X	
Check door for alignment			X	
Check hoses and connections			X	
Clean door seal	X			
Verify air blower functions and controls work properly			X	
Verify whirlpool function and controls			X	
Clean whirlpool suction fitting inlet		X		
Check GFCI			X	
Check to make sure access panels are secured			X	
Check diverter, hot, and cold handles to be secure and not loose			X	
Clean hot and cold water inlet screens			X	

Troubleshooting

Problem / Issue	Check	Action / Solution
Door is Leaking	Check door seal	Re-attach door seal if loose or replace if damaged. Go to Section 6 (Maintenance and Adjustments)
	Check door positioning	Adjust door. Go to Section 6 (Maintenance and Adjustments)
Water too hot or too cold	Check hose washer / screen in end of supply hoses	Remove and check for debris or build-up, clean or replace if needed
	Check hot and cold supply lines for kink(s) or damage	Remove kink(s) or replace if needed
	Check if water supply dynamic pressures are within 10% of each other	Consult with a local Plumber
Valve package not working properly (ie. hot and cold levers, diverter, tub-fill)	Check lever(s)	Tighten set screw on lever(s) (Go to Section 8.1)
	Check cartridges (hot, cold, and diverter valves)	Replace cartridges if needed (Go to Section 8.1)
Door swings open or closes by itself	Check if tub is level	Adjust feet and level the tub
	Check door positioning	Adjust door. Go to Section 6 (Maintenance and Adjustments)
Door will not open or close properly	Check door seal for soap scum or mildew build-up	Clean with mild soapy water and let dry, then put baby powder on the seal.
	Check door positioning	Adjust door. Go to Section 6 (Maintenance and Adjustments)
Air Spa not working properly (if equipped)	Check if plugged into outlet and/or damage to the electrical cord	Plug-in and/or replace the electrical cord if needed
	Check if GFCI outlet is working properly	Reset GFCI outlet / breaker
	Check gray hose for either kink(s) or has come off the air spa motor or manifold	Remove kink(s) or re-attach gray hose to air spa motor or manifold by tightening the hose clamps
	Check for User error	Go to Section 2 (Using the Tub)
Whirlpool not working properly (if equipped)	Check if plugged into outlet and/or damage to the electrical cord	Plug-in and/or replace the electrical cord if needed
	Check if GFCI outlet is working properly	Reset GFCI outlet / breaker
	Check suction fitting inlet	Clean and/or remove obstruction (hair, build-up, or debris)
	Check for User error	Go to Section 2 (Using the Tub)
Aromatherapy not working properly (if equipped)	Check if GFCI outlet is working properly	Reset GFCI outlet / breaker
	Check for User error	Go to Section 2 (Using the Tub)
Chromatherapy not working properly (if equipped)	Check if GFCI outlet is working properly	Reset GFCI outlet / breaker
	Check for User error	Go to Section 2 (Using the Tub)

PARTS (Deck Mount Plumbing Package)



BREAK DOWN Component Parts List

#	PARTNAME	QTY
1	LEVER HANDLE	3
2	CARTRIDGE RETAINING NUTS	2
3	FLANGE STEP W/ RUBBERRING	2
4	HOT AND COLD CARTRIDGES	1 ea.
5	METAL WASHER	2
6	LOCK NUT	2
7	HOT AND COLD VALVES	1 ea.
8	SPOUT W/ SHANK	1
9	SPOUT RING	1
10	METAL WASHER	1
11	LOCK NUT	1
12	HOSE	2
13	TRANSFER VALVE SET	1
14	HAND SHOWER HOLDER ASSEMBLY	1
15	45 DEGREE ELBOW	1
16	HAND SHOWER	1

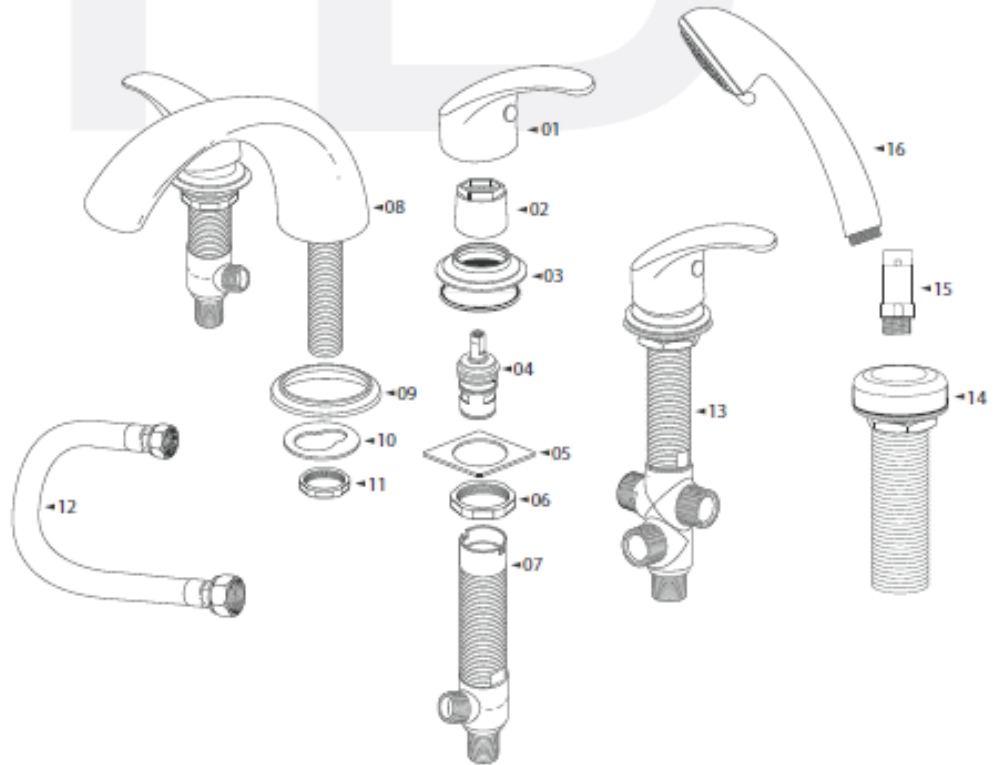

#	Part #	Description
1	3743	Lever Handle
4	3753	Cartridge (Cold Valve)
4	3754	Cartridge (Hot Valve)
14	1865	Deck Mount Shower Wand Holder, chrome
15	1866	45° Elbow w/ backflow prevention, chrome
16	1895	Shower Wand, chrome

PARTS (Aromatherapy)

COMPONENTS

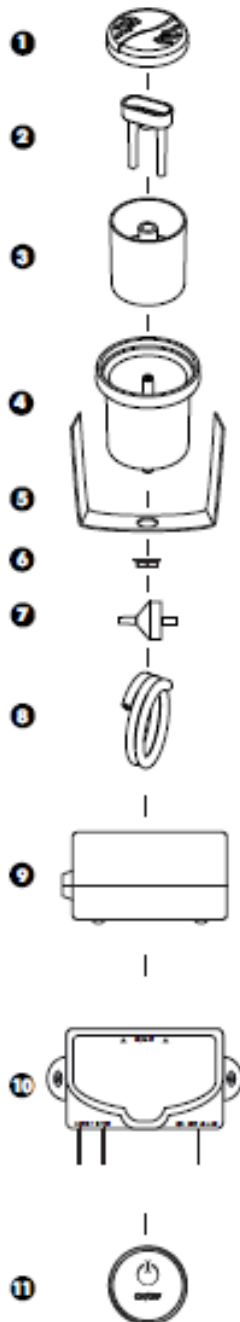

#	Part #	Description
1	3425	Cap, chrome
2	3758	Aroma Tubes
3	3759	Internal Bowl
7	3428	Check Valve, 1/8"
9	3433	Air Pump w/NEMA plug
11	3431	Touch / Keypad

INSTALLATION

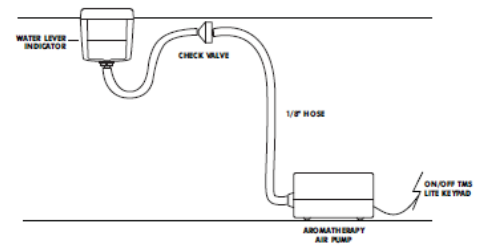

The system works using an air pump which leads the air towards the receptacle filled with water added with some essential oil drops.

1: Cap	AROMA-CAP-**
2: Tubes	AROMA-TUBES
3: Internal container	AROMA-BOL-INT
4: External container	AROMA-BOL-EXT
5: Bracket	BRACKET-AROMA
6: Lock nut	LOCKNUT-1/4
7: Check valve 1/8"	CH-VALVE-1/8-AROMA
8: 5' hose 1/8"	TUYAU-1/8_AIRPUSH_5'
9: Aromatherapy air pump	AROMA-POMPE-N
10: TMS Lite electronic control	IC-TMSPT-120/60-002-N-N-12"
11: On/Off TMS Lite keypad	CG-TMS1-KR1CC01-**-*

PARTS (Chromatherapy)

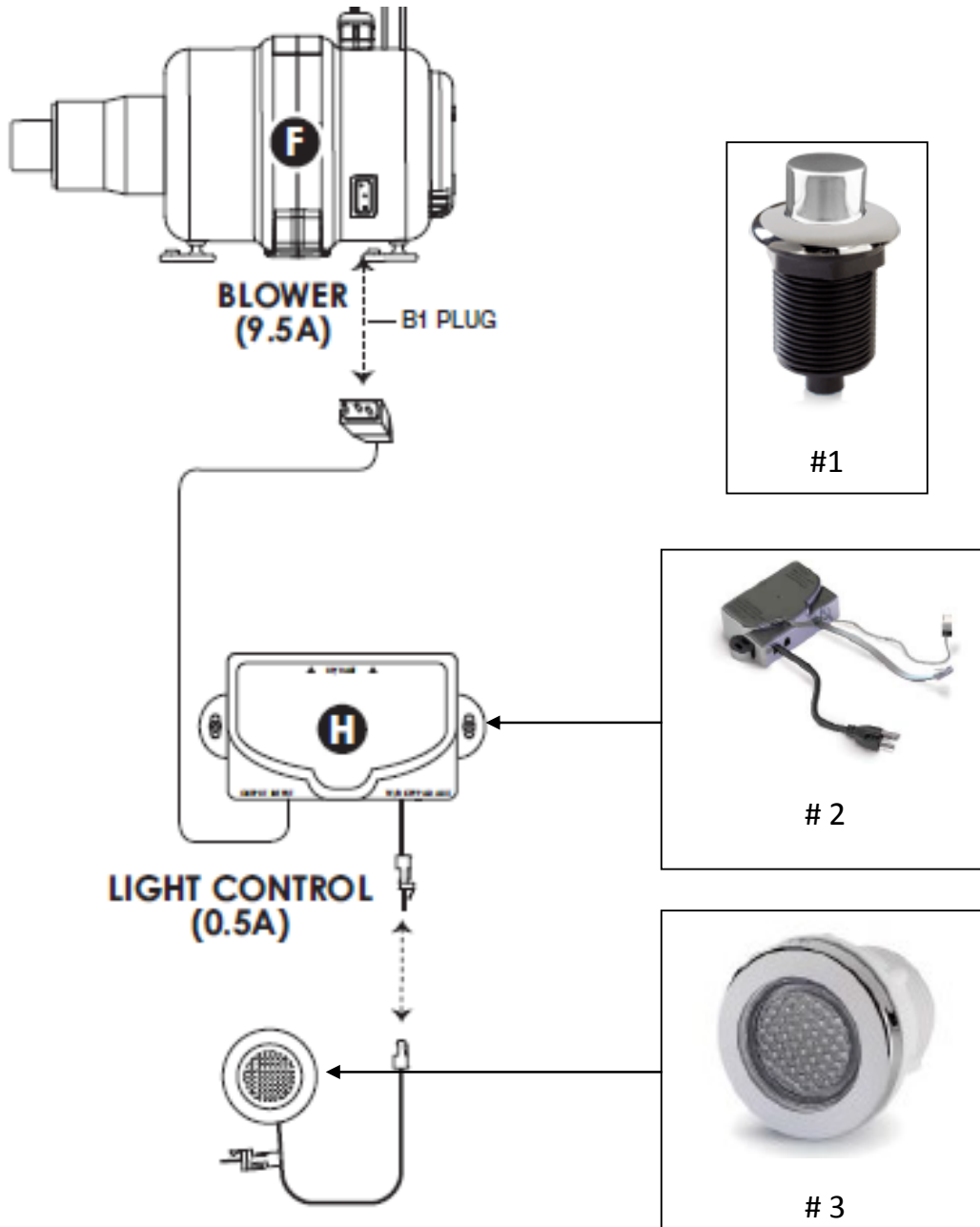

#	Part #	Description
1	3716	Air Switch, High-Rise Button, chrome (Off / On)
2	3437	Control Box
3	3436	Mini-Light, 9 LED Bulb (includes Round Flange and Cable)