



health at home, inc.
Enhancing Safety, Vitality & Longevity at Home

Bilanx bathing collection®

strike the balance Design Safety

HH-SB4842-C-WHT

FEATURES

- ArmorCore™ slip resistant, textured bottom
- Left or right hand drain
- Low 3" threshold
- Integrated weep holes
- Sloped threshold ensures water containment
- Pre-leveled legs, no mortar bed required
- Sleek minimalist design
- AcrylX™ applied acrylic surface
- Lifetime limited warranty

COLOR OPTIONS

White Standard

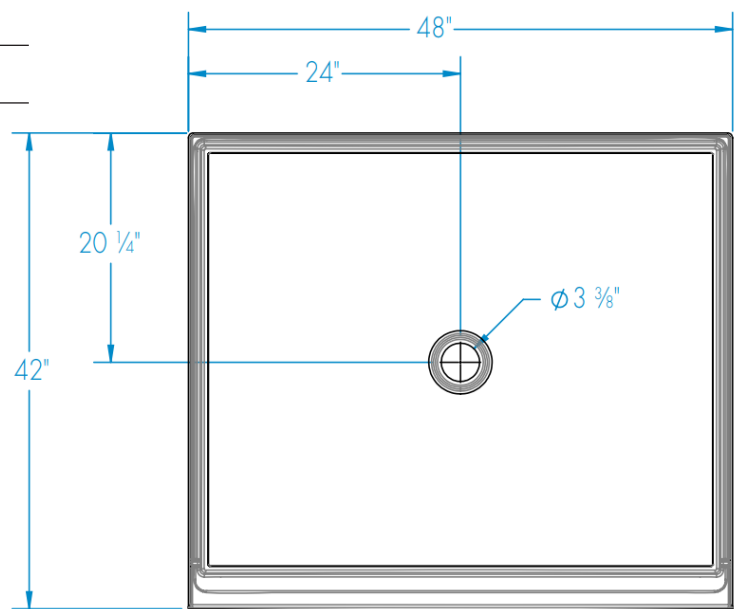

DIMENSIONS

Specifications	inches
Width: Overall / Net	48
Depth: Overall / Net	42
Height: Overall / Net	4 1/4 / 3
Enclosure Opening	-
Skirt Height	3
Drain Rough-In (from Back Wall)	20 1/4
Drain Rough-In (from Side Wall)	24
Drain: Diameter / Clearance	3 3/8 / 3/8

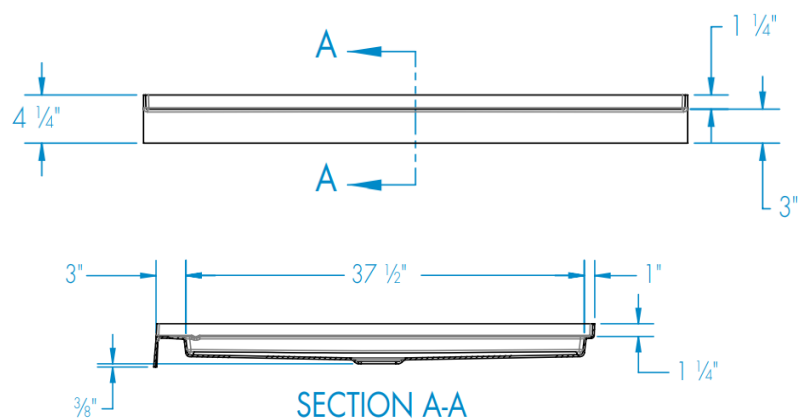

Dimensional Tolerance $\pm 3/8"$.

Dimensions needed for site preparation should be measured from the unit. Manufacturer assumes no responsibility for preparatory work.

ORDER ENTRY BY FAX 888.802.8186 OR EMAIL orders@healthathomeinc.com

Office 704.960.0148 or 980.900.2845 www.healthathomeinc.com

Products that enhance safety, vitality, & longevity at home.