



health at home, inc.  
Enhancing Safety, Vitality & Longevity at Home

*Bilanx* bathing collection®

strike the balance Design Safety

# HH-SB3636-C-WHT

## FEATURES

- ArmorCore™ slip resistant, textured bottom
- Left or right hand drain
- Low 3" threshold
- Integrated weep holes
- Sloped threshold ensures water containment
- Pre-leveled legs, no mortar bed required
- Sleek minimalist design
- AcrylX™ applied acrylic surface
- Lifetime limited warranty

## COLOR OPTIONS

White Standard

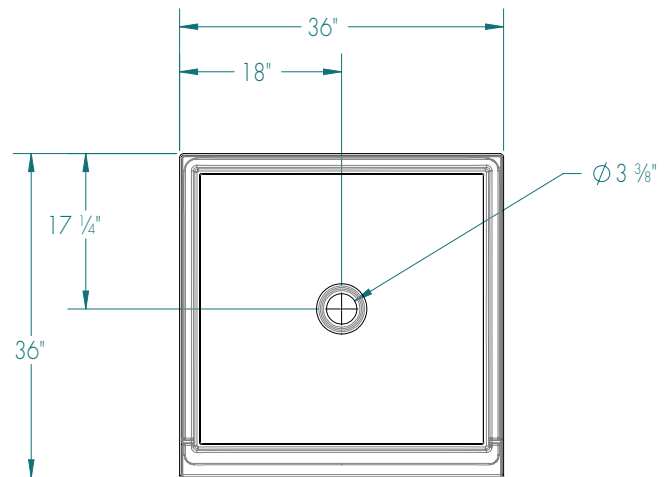

## DIMENSIONS

Specifications	inches
<b>Width:</b> Overall / Net	36
<b>Depth:</b> Overall / Net	36
<b>Height:</b> Overall / Net	4 1/4 / 3
<b>Enclosure Opening</b>	-
<b>Skirt Height</b>	3
<b>Drain Rough-In</b> (from Back Wall)	17 1/4
<b>Drain Rough-In</b> (from Side Wall)	18
<b>Drain:</b> Diameter / Clearance	3 3/8 / 3/8

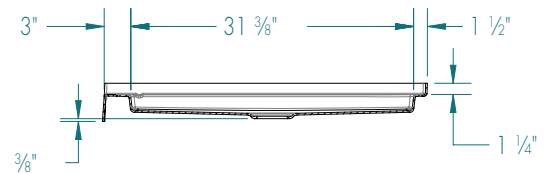

Dimensional Tolerance  $\pm 3/8"$ .

Dimensions needed for site preparation should be measured from the unit. Manufacturer assumes no responsibility for preparatory work.

ORDER ENTRY BY FAX 888.802.8186 OR EMAIL [orders@healthathomeinc.com](mailto:orders@healthathomeinc.com)

Office 704.960.0148 or 980.900.2845 [www.healthathomeinc.com](http://www.healthathomeinc.com)

*Products that enhance safety, vitality, & longevity at home.*